

KBGS121200 12V 120Ah



The Kaise Solar range is mainly used in the renewable energies industry, given their optimal performance in cyclic use. With lower acid density, excess of electrolyte and larger distance between plates the batteries maintain a low temperature and also slows down the plate grid corrosion speed. These batteries have a unique plate grid configuration which, alongside the high quality AGM separator and the battery management system, ensures the batteries have a longer service life. The valves were specially designed to control water loss and prevent air and other elements from getting in.

Performance Characteristics

Nominal Voltage	12V		
Dimensions	Length (mm / inch)	330 / 12.99	
	Width (mm / inch)	173 / 6.81	
	Height (mm / inch)	212 / 8.35	
	Total Height (mm / inch)	220 / 8.66	
Approx. Weight	(Kg / lbs)	30.6 / 67.47	
Design Life	8 - 12 years		
Terminal	M8		
Container Material	ABS		
Rated Capacity	120.0 Ah / 1.2 A	(100hr, 1.80V/cell, 25°C / 77°F)	
	104.0 Ah / 5.20 A	(20hr, 1.80V/cell, 25°C / 77°F)	
	100.0 Ah / 10.0 A	(10hr, 1.80V/cell, 25°C / 77°F)	
	86.0 Ah / 17.2 A	(5hr, 1.75V/cell, 25°C / 77°F)	
	78.0 Ah / 26.0 A	(3hr, 1.60V/cell, 25°C / 77°F)	
Max. Discharge Current	1200A (5s)		
Internal Resistance	Approx 4.9mΩ		
Operating Temp. Range	Discharge : -15 ~ 50°C (5 ~ 122°F)		
	Charge : 0 ~ 40°C (32 ~ 104°F)		
	Storage : -15 ~ 40°C (5 ~ 104°F)		
Nominal Operating Temp. Range	25 ± 3°C (77 ± 5°F)		
Cycle Use	Initial Charging Current less than 24A		
	Voltage: 14.4V ~ 15.0V at 25°C (77°F)		
	Temp. Coefficient: -30mV/°C		
Standby Use	Initial Charging Current less than 24A		
	Voltage: 13.5V ~ 13.8V at 25°C (77°F)		
	Temp. Coefficient: -20mV/°C		
Capacity affected by Temperature	40°C (104°F)	103%	
	25°C (77°F)	100%	
	0°C (32°F)	86%	
Self Discharge	Fully charged Kaise Solar Series batteries may be stored for up to 6 months at 25°C (77°F) and then a freshening charge is required. For higher temperatures the time interval will be shorter.		

Constant Current Discharge (Amperes) at 77°F (25°C)

Volts/cell	15min	30min	45min	1h	5h	10h	20h	100h
1.80V	138.3	89.8	67.0	52.8	16.8	10.0	5.20	1.20
1.75V	151.0	93.2	69.5	55.3	17.2	10.1	5.25	1.25
1.70V	161.2	97.0	72.3	57.0	17.7	10.2	5.35	1.35
1.65V	171.4	102.3	74.1	58.9	18.1	10.4	5.42	1.42
1.60V	183.4	108.0	77.2	61.0	18.7	10.5	5.45	1.45

Dimensions and Terminal (Unit: mm (inches))

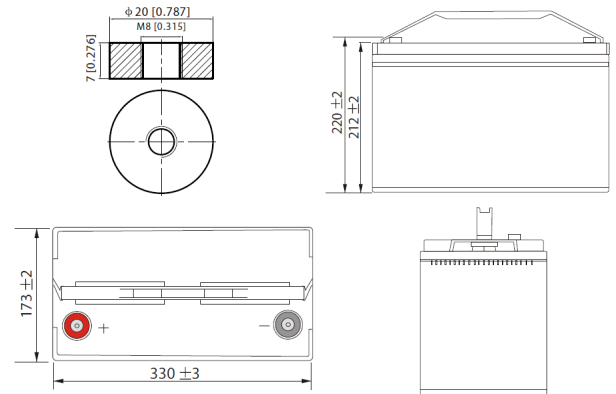

Applications

- Renewable Energy
- Alarm systems
- Electric Test Equipment
- Emergency lighting systems
- Marine equipment
- Telecommunications systems

Certifications

ISO 9001:2008 ISO 14001:2008



Discharge Current vs. Discharge Voltage

Final discharge voltage V/CELL	1.8	1.75	1.7	1.6
Discharge current (A)	I ≤ 0.1CA	0.25CA ≥ I > 0.1CA	0.55CA ≥ I > 0.25CA	I > 0.55CA

Constant Power Discharge (Watts per cell) at 77°F (25°C)

Volts/cell	15min	30min	45min	1h	5h	10h	20h
1.80V	254.5	168.5	127.7	101.3	32.8	19.8	10.3
1.75V	274.6	173.5	131.3	105.5	33.5	19.9	10.4
1.70V	289.1	179.5	136.0	108.5	34.3	20.1	10.6
1.65V	305.0	187.8	138.1	111.3	35.1	20.5	10.7
1.60V	320.8	196.9	143.2	114.7	36.2	20.7	10.8

(Note) The above characteristics data are average values obtained within three charge/discharge cycles not the minimum values.

Charging Characteristic (float use)

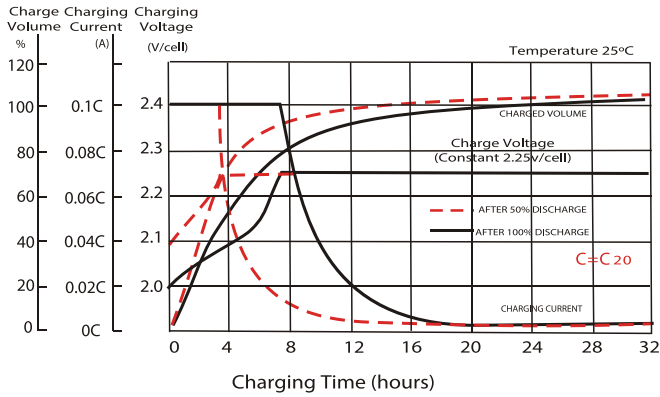

General Relation of Capacity vs. Storage Time

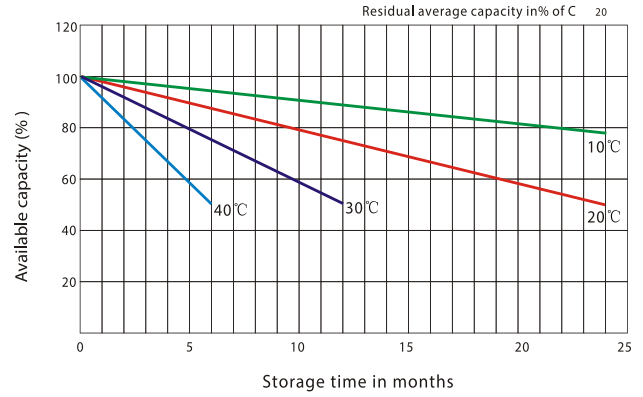

Temperature Effects in Relation to Battery Capacity

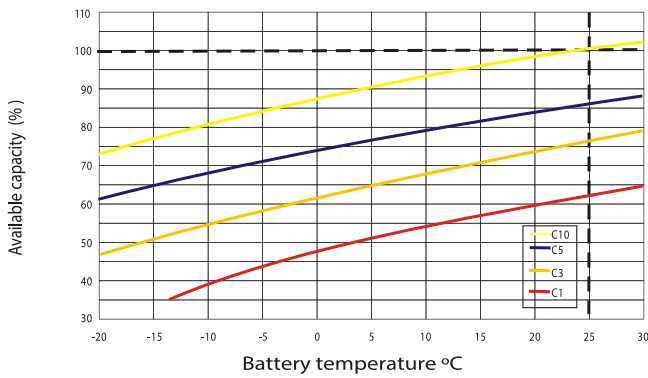

Effect of Temperature on Long Term Float Life

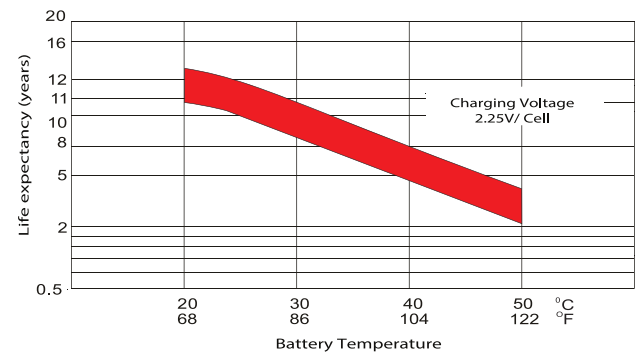

Cycle Life in Relation to Depth of Discharge

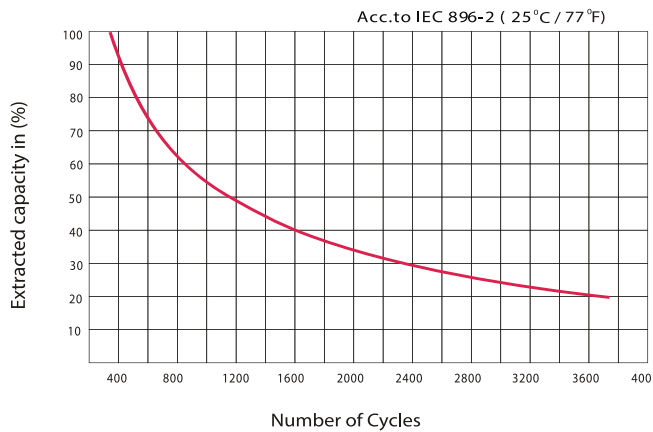

IMPORTANT NOTE: The specifications presented herein are subject to revision without notice.

