

KBGS121400 12V 140Ah



The Kaise Solar range is mainly used in the renewable energies industry, given their optimal performance in cyclic use. With lower acid density, excess of electrolyte and larger distance between plates the batteries maintain a low temperature and also slows down the plate grid corrosion speed. These batteries have a unique plate grid configuration which, alongside the high quality AGM separator and the battery management system, ensures the batteries have a longer service life. The valves were specially designed to control water loss and prevent air and other elements from getting in.

Performance Characteristics

Nominal Voltage	12V	
Dimensions	Length (mm / inch)	408 / 16.1
	Width (mm / inch)	177 / 6.97
	Height (mm / inch)	225 / 8.86
	Total Height (mm / inch)	225 / 8.86
Approx. Weight	(Kg / lbs) 34.0 / 75.0	
Design Life	8 - 12 years	
Terminal	M8	
Container Material	ABS	
Rated Capacity	140.0 Ah / 1.40 A	(100hr, 1.80V/cell, 25°C / 77°F)
	124.8 Ah / 6.24 A	(20hr, 1.80V/cell, 25°C / 77°F)
	120.0 Ah / 12.0 A	(10hr, 1.80V/cell, 25°C / 77°F)
	103.0 Ah / 20.6 A	(5hr, 1.75V/cell, 25°C / 77°F)
	93.6 Ah / 31.2 A	(3hr, 1.60V/cell, 25°C / 77°F)
Max. Discharge Current	1300A (5s)	
Internal Resistance	Approx 7.5mΩ	
Operating Temp. Range	Discharge : -15 ~ 50°C (5 ~ 122°F)	
	Charge : 0 ~ 40°C (32 ~ 104°F)	
	Storage : -15 ~ 40°C (5 ~ 104°F)	
Nominal Operating Temp. Range	25 ± 3°C (77 ± 5°F)	
Cycle Use	Initial Charging Current less than 28A	
	Voltage: 14.4V ~ 15.0V at 25°C (77°F)	
	Temp. Coefficient: -30mV/°C	
Standby Use	Initial Charging Current less than 28A	
	Voltage: 13.5V ~ 13.8V at 25°C (77°F)	
	Temp. Coefficient: -20mV/°C	
Capacity affected by Temperature	40°C (104°F)	103%
	25°C (77°F)	100%
	0°C (32°F)	86%
Self Discharge	Fully charged Kaise Solar Series batteries may be stored for up to 6 months at 25°C (77°F) and then a freshening charge is required. For higher temperatures the time interval will be shorter.	

Constant Current Discharge (Amperes) at 77°F (25°C)

Volts/cell	15min	30min	45min	1h	5h	10h	20h	100h
1.80V	165.9	107.7	80.4	63.4	20.1	12.0	6.24	1.40
1.75V	181.2	111.8	83.4	66.3	20.6	12.1	6.30	1.44
1.70V	193.5	116.4	86.7	68.4	21.2	12.2	6.42	1.49
1.65V	205.7	122.8	88.9	70.7	21.8	12.5	6.50	1.52
1.60V	220.0	129.6	92.6	73.2	22.5	12.6	6.54	1.53

Dimensions and Terminal (Unit: mm (inches))

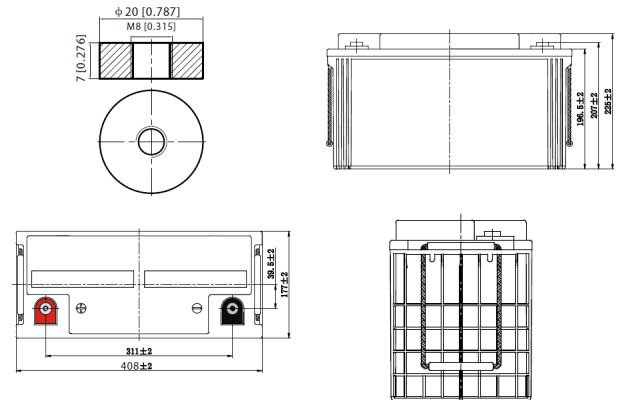

Applications

- Renewable Energy
- Alarm systems
- Electric Test Equipment
- Emergency lighting systems
- Marine equipment
- Telecommunications systems

Certifications

ISO 9001:2008 ISO 14001:2008



Discharge Current vs. Discharge Voltage

Final discharge voltage V/CELL	1.8	1.75	1.7	1.6
Discharge current (A)	I ≤ 0.1CA	0.25CA ≥ I > 0.1CA	0.55CA ≥ I > 0.25CA	I > 0.55CA

Constant Power Discharge (Watts per cell) at 77°F (25°C)

Volts/cell	15min	30min	45min	1h	5h	10h	20h
1.80V	305.4	202.2	153.2	121.6	39.3	23.7	12.3
1.75V	329.5	208.1	157.5	126.6	40.2	23.9	12.4
1.70V	346.9	215.4	163.2	130.2	41.1	24.1	12.7
1.65V	366.0	225.4	165.8	133.6	42.1	24.6	12.8
1.60V	385.0	236.3	171.8	137.6	43.4	24.8	12.9

(Note) The above characteristics data are average values obtained within three charge/discharge cycles not the minimum values.

Charging Characteristic (float use)

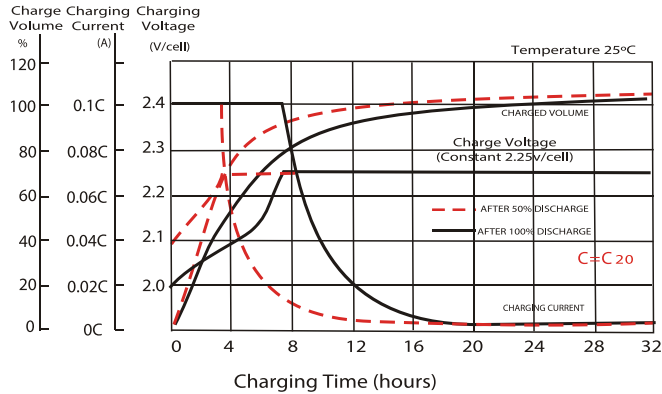

General Relation of Capacity vs. Storage Time

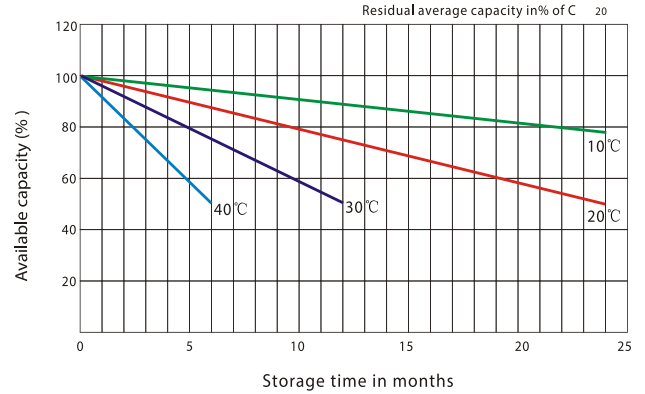

Temperature Effects in Relation to Battery Capacity

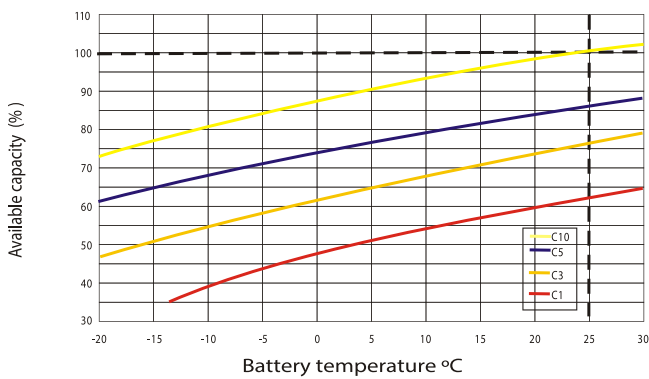

Effect of Temperature on Long Term Float Life

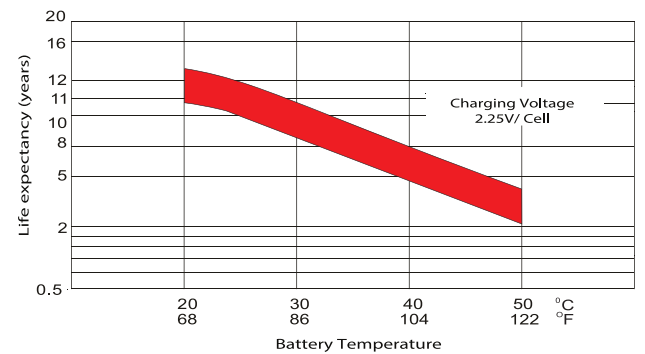

Cycle Life in Relation to Depth of Discharge

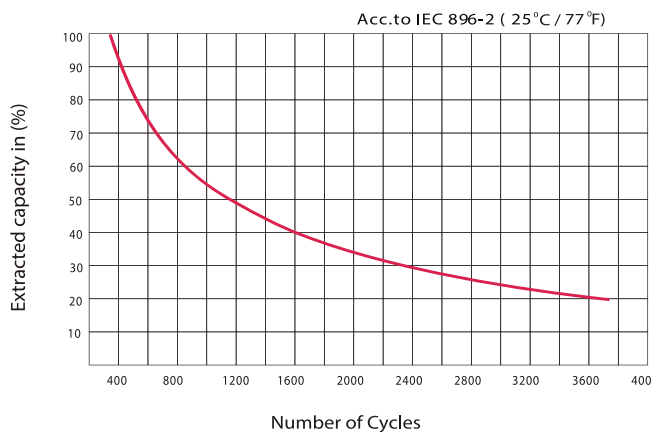

IMPORTANT NOTE: The specifications presented herein are subject to revision without notice.

